



UNPACKING

Your PR16 Lab Permeameter has been thoroughly tested before shipment. When packed, it was in perfect working order. Unpack with care, being sure to remove all packing material. Follow the instructions carefully in order to ensure long, trouble-free service. Any damage found upon receipt should be reported immediately to the transport carrier for claim. It is important to save the shipping container and all evidence to support your claim. Be sure to read all operating instructions thoroughly before operating the unit.

WARRANTY & LIABILITY

Soilmoisture Equipment Corp. (SEC) warrants all products manufactured by SEC to be free from defects in materials and workmanship under normal use and service for twelve (12) months from the date of invoice provided the section below has been met. Soilmoisture Equipment Corp. (SEC) is not liable for any damage, actual or inferred, caused by misuse or improper handling of its products. SEC products are designed to be used solely as described in these product operating instructions by a prudent individual under normal operating conditions in applications intended for use by this product.

Features

The PR16 Lab Permeameter is an accurate and fully automated laboratory system for measuring *soil core saturated hydraulic conductivity* (K_{sat}). The PR16 is capable of performing K_{sat} measurement according to *Falling-Head Method* and also *Constant-Head Method* procedures. Thanks to the **Monitor® Precision Pressure Transducer**, and the **Chameleon Software Application**, both measurement methods are fully automated. The PR16 comes with all required components (computer is NOT included in the standard kits).

Applications:

Laboratory hydraulic conductivity measurement is a very common measurement method used in educational applications, agricultural research, irrigation projects, construction projects, mining sites studies, oil industry, environmental studies, geological studies and more.

Specifications

Standard Reservoir:

Reservoir Inside Diameter: 5.13 cm

Reservoir Increments: 5 cm to 45 cm, 1 mm resolution.

Reservoir Cross-Sectional Area: 20.67 cm²

Reservoir Volume: 930 mL

50 mm ID Sample Ring (Model PR16 and Model PR16-5)

Sample Ring Inside Diameter: 5.0 cm

Sample Ring Height: 5.0 cm

Sample Ring Inside Cross-Sectional Area: 19.6 cm²

Sample Ring Volume: 98.2 mL

80 mm ID Sample Ring (Model PR16-81, PR16-85)

Sample Ring Inside Diameter: 8 cm

Sample Ring Height: 5.0 cm

Sample Ring Cross-Sectional Area: 50.3 cm²

Sample Ring Volume: 251.3 mL

Pressure Transducer: Monitor™ Precision Transducer (-100 kPa to +100 kPa). Please refer to the product manual for more details.

System Resolution: 0.1 cmH₂O (0.01 kPa)

Software Application: Please refer to Monitor Transducer Software Application manual.

NOTE: The Chameleon Software Application (for PC) can control up to independent **20** independent units simultaneously.

System Options

Model PR16: Single Unit, Flow Cell: 5.0 cm ID, 5.0 cm Length

Model PR16-5: Five Independent Units, Flow Cell: 5.0 cm OD, 5.0 cm Length

Model PR16-81: Single Unit, Flow Cell: 8.0 cm ID, 5.0 cm Length

Model PR16-85: Five Independent Units, Flow Cell: 8.0 cm ID, 5.0 cm Length

Acquaint Yourself with the PR16 Components

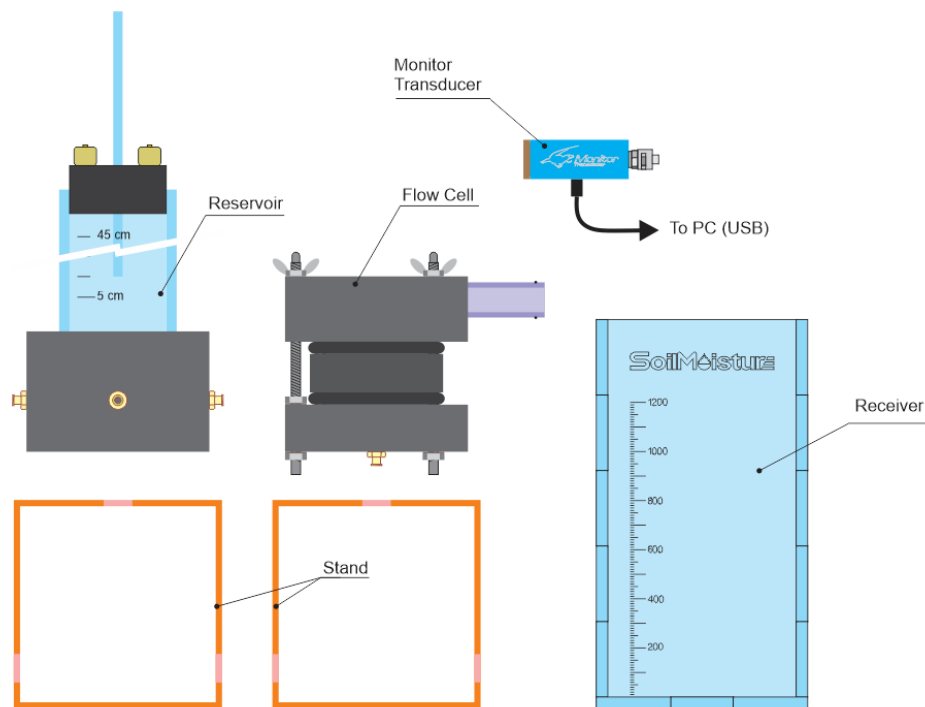

Major Components of the PR16 Setup.

PR16 Flow Cell

1. Flow Cell Stud
2. Stud Wingnut
3. Flow Cell Cap
4. Perforated Plate
5. Mesh Screen
6. Cylinder O-ring
7. Sample Ring
8. Stud Nut
9. Stud Washer
10. Paper Filter Retainer
11. Flow Cell Base O-ring
12. Flow Cell Base Port
13. Paper Filter
14. Flow Cell Base
15. Spacer Cylinder
16. Drainage Pipe
17. Drainage Pipe O-ring

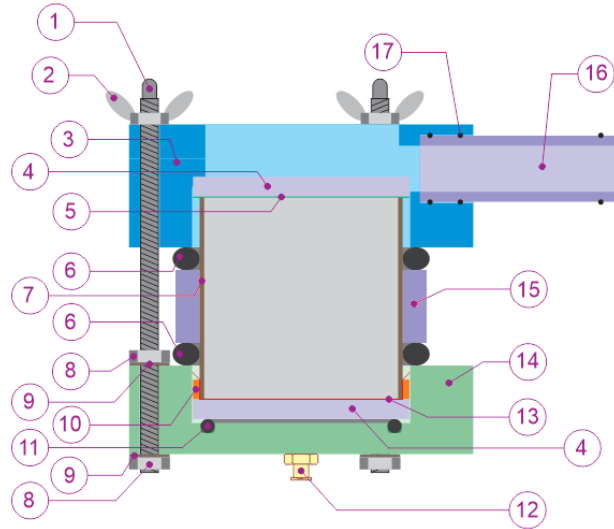

PR16 Reservoir

20. Air Tube
21. Top Port
22. Stopper
23. Body Pipe
24. Base
25. Side Port

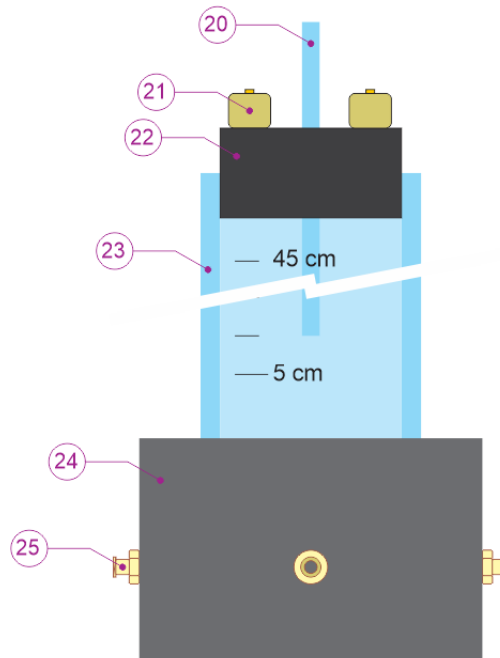

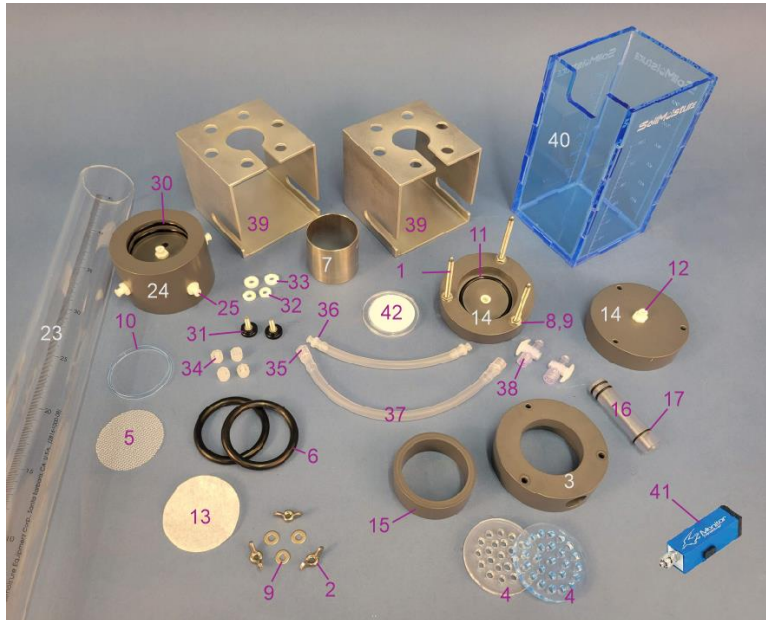

PR16 Parts

- | | |
|-------------------------------|---------------------------------------------------------------------------|
| 30. Reservoir O-ring | 36. Female Luer Hose Connection |
| 31. Stand Knob | 37. Tubing |
| 32. Knob Centralizer | 38. Stopcock |
| 33. Knob Spacer | 39. Stand |
| 34. Port Plug | 40. Receiver |
| 35. Male Luer hose Connection | 41. Monitor™ Precision Pressure Transducer |
| | 42. Extraction Plate (not included, not needed for K_{sat} measurement) |

Software Installation

NOTE: The latest version of the Chameleon Software Application can always be downloaded for free from the SoilMoisture webpage below.

<https://www.soilmoisture.com/resources/Software-Downloads/>

+ Open the Windows Explorer, go to the USB drive and run “setup.exe” file.

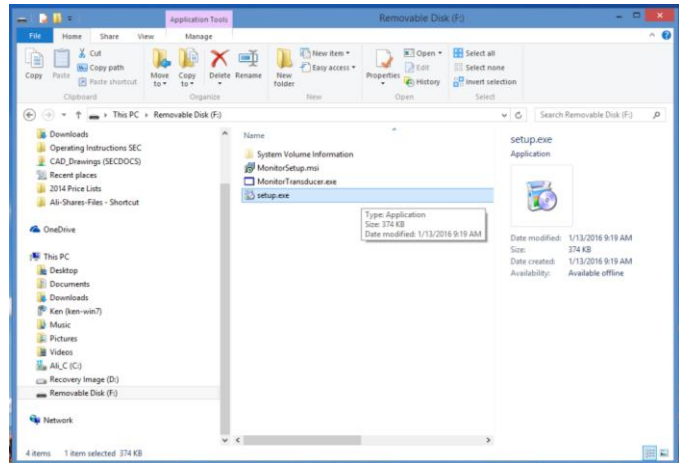

+ Click “Next” in the “Monitor Transducer” window.

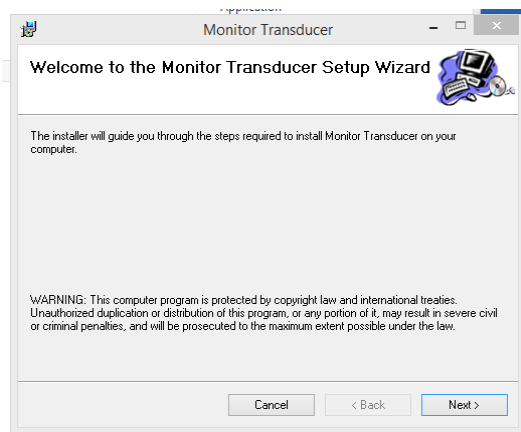

+ Click the “Browse” Button in the “Select Installation Folder” window to select the installation folder.

We recommend the default folder “C:\SEC\Monitor\”. Click the “Disk Space” to see a list of your drives and space available on each of them.

Select “Everyone” if you would like other people to access to the program. Otherwise select the “Just me” option.

Click “Next” when you are done.

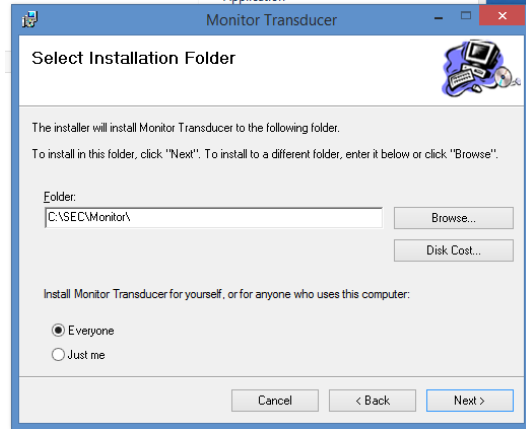

+ Select “Next” in the “Confirm Installation” window if you would like the software to get installed on your computer.

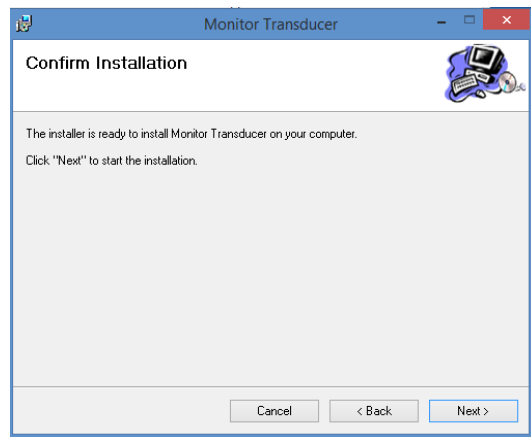

+ The following window pops up. Please wait. The installation process should not take longer than a couple of minutes.

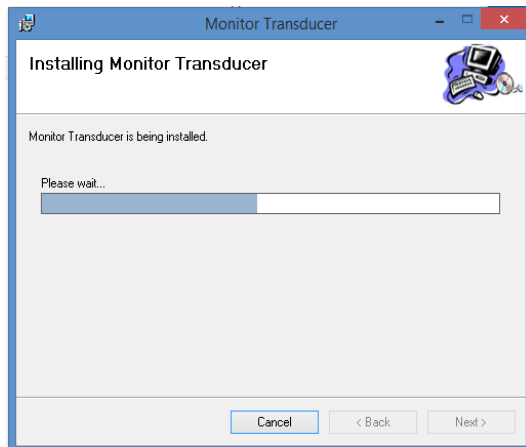

+ Click “Close” in the “Installation Complete” window.
A Windows Shortcut (Monitor Transducer) will be
created on your computer Desktop.



Assemble the Reservoir

Assemble the Reservoir according to the
schematic.

Use a small amount of Vacuum Grease to lubricate
the Air Tube and insert it in the central hole of the
Stopper.

Secure the Base to Stand using Stand Knobs and
items 31 and 32.

Before attaching the Body Pipe to the Base make
sure that the Reservoir O-rings are in place.
Lubricate the O-rings with Vacuum Grease if
needed.

Secure the Stopper to the top of the Pipe and make
sure that it is sealed to the Pipe (airtight).

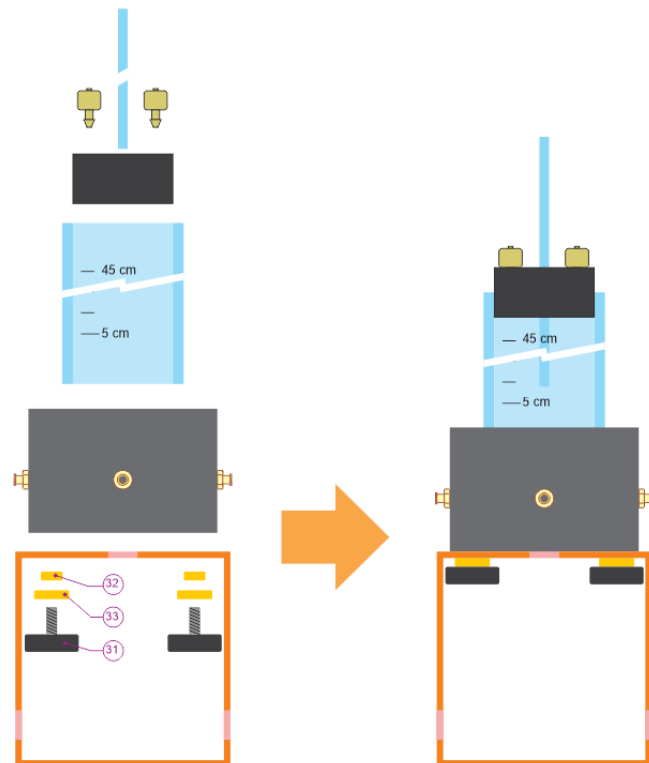

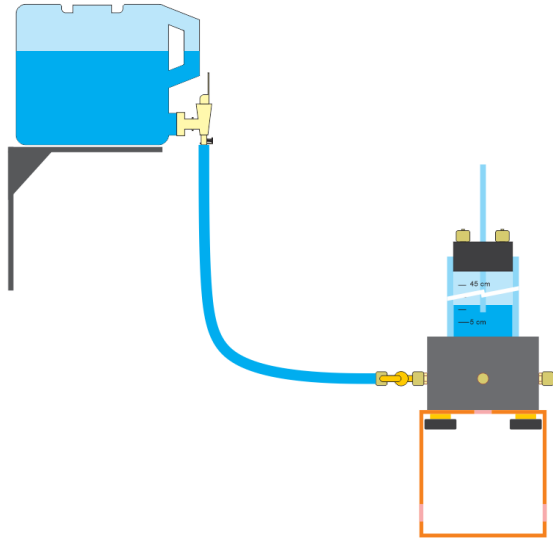

The Reservoir has 4 side ports. One of them can be used for refilling the Reservoir. This eliminates the need to remove the Stopper for refilling.

You can connect the Reservoir to tap water, or to an elevated water reservoir (see the schematic).

NOTE: the “elevated reservoir” is NOT included.

NOTE: in case you connect the Reservoir to a water tap, close the water faucet after each refilling.

Assemble the Sample Ring

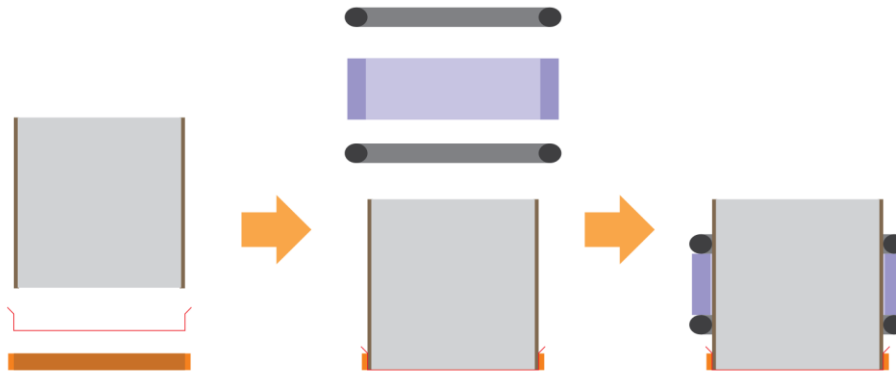

Place the Paper Filter Retainer over an even surface like tabletop. Then place a Paper Filter over it. Try to center the Filter with the Retainer. Now, carefully place the Sample Ring over the Paper Filter and gently push it into the Paper Filter Retainer. If the Paper Filter torn, try again with a new Filter

Insert the Cylinder O-rings and Spacer Cylinder around the Sample Ring (see the schematic above).

Saturate the Soil Sample

Connect a Stopcock to the Flow Cell Base and another Stopcock to the Reservoir Base.

Then connect the Reservoir to the Flow Cell Base using the Tubing provided.

Considering the vertical and horizontal distance of the Reservoir and the Flow Cell, cut the tubing to a length that is convenient and not too long. A length of 15 to 20 cm is recommended.

Open the Stopcocks and let water flow freely and fill up a bout $\frac{3}{4}$ of the Flow Cell Base.

You also need to get rid of all bubbles in the water path between the Reservoir and the Flow Cell Base. You'll be able to do this effectively with a little practice. Note that very small bubbles that do not limit the flow rate significantly do not create any issues.

Make sure that the Flow Cell O-ring is in place. Submerge one of the Perforated Plates in the water collected inside the Flow Cell Base.

Make sure that all three Drainage Pipe O-rings are in place. Connect the Drainage Pipe to the Cap.

Carefully place the Sample Ring (containing soil) on top of the Perforated Plate. Try not to trap air bubbles under the Sample Ring.

Once the Sample Ring sits in place, carefully place the Mesh Screen on top of it. Now, place the second Perforated Plate over the Mesh Screen.

Align the Flow Cell Cap with the three Studs and gently push it down. Centralize the Perforated Plate and the Mesh Screen to go into the Cap. The

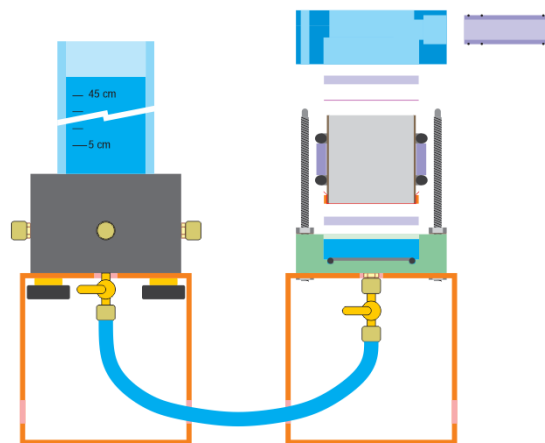
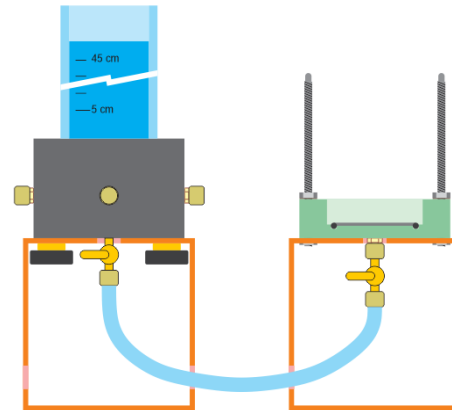

bottom of the Cap should easily touch the Cylinder O-ring.

Once the Cap is in place, put the Wingnuts over the Studs and secure them “half turn at a time”. This method is like securing the spare tire of a car. It ensures even progress among the Wingnuts.

Please note that there is no need for overtightening the Wingnuts. Do NOT use any tools or leverage for tightening the Wingnuts!

Secure the Stopper to the top of the Reservoir. Adjust the Air Tube at the 5 cm mark. This creates a small overhead pressure. Connect Stopcocks to the Stopper ports and close the Stopcocks.

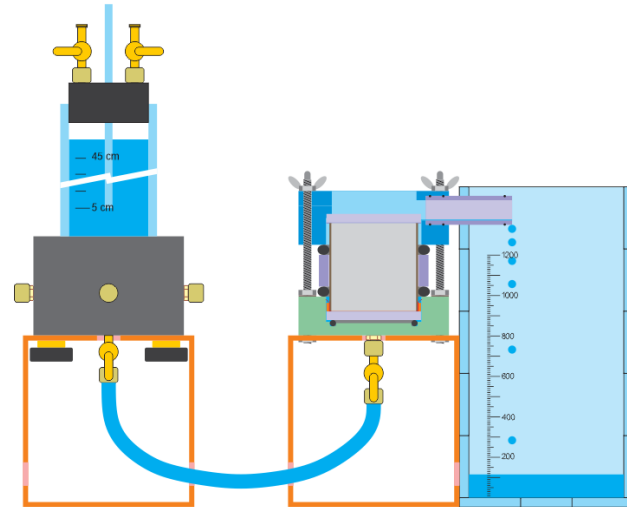

Now open the Stopcocks connected to the Tubing. Water starts flowing from the Reservoir to the Flow Cell due to the head height difference. The Air Tube should also start bubbling, which indicates water consumption from the Reservoir.

Place the Receiver next to the Flow Cell to collect the drainage water.

Wait until the soil is completely saturated. Depending on the soil type, and the length of the sample, this might take from several minutes to several days. Most ‘regular’ soils need a day to get saturated.

Detecting free water on top of the soil sample and in the Drainage Pipe are signs that the soil is saturated.

Measurement Campaign: Constant Head Method

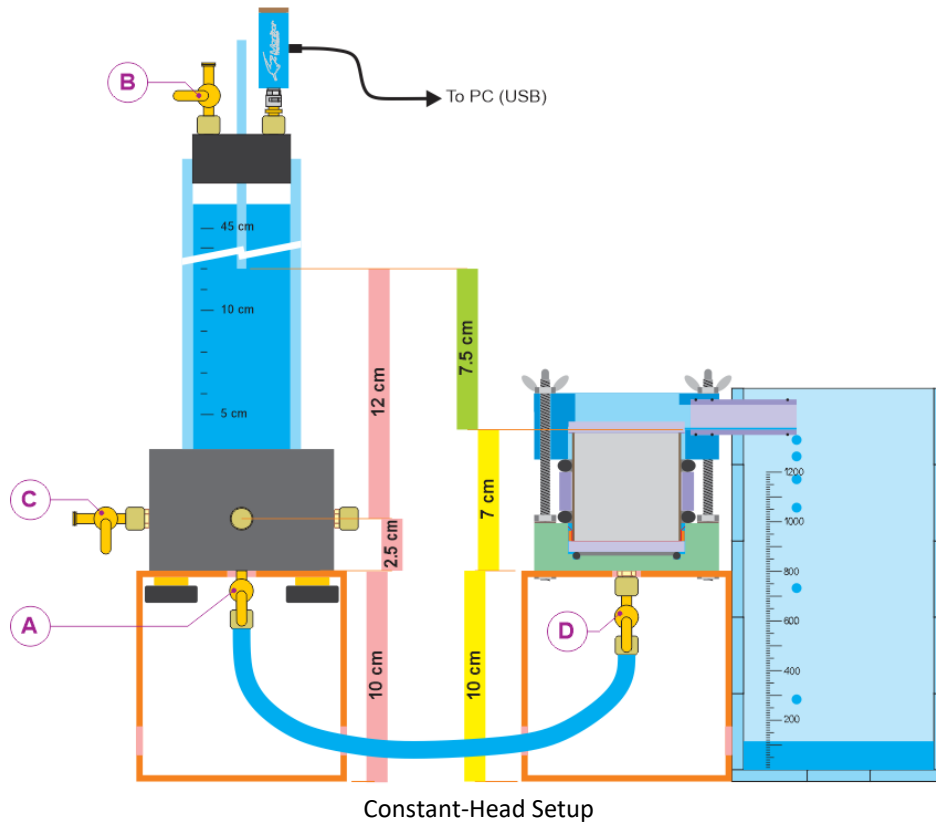

- + Set up the system according to the schematic attached.
- + Connect the Monitor Transducer to your computer using the USB cable provided with the system.
- + Open the Monitor Transducer program.
- + Make sure that Valve B is open (schematic above). This is to expose the pressure sensor to ambient air.

+ Open the Monitor Transducer from your Desktop.

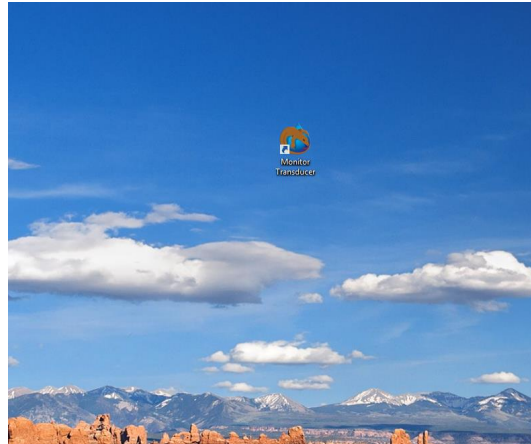

+ If the Monitor sensor reads a pressure other than zero, go to “Monitor” menu then click “Zero”. The pressure reading should go to zero.

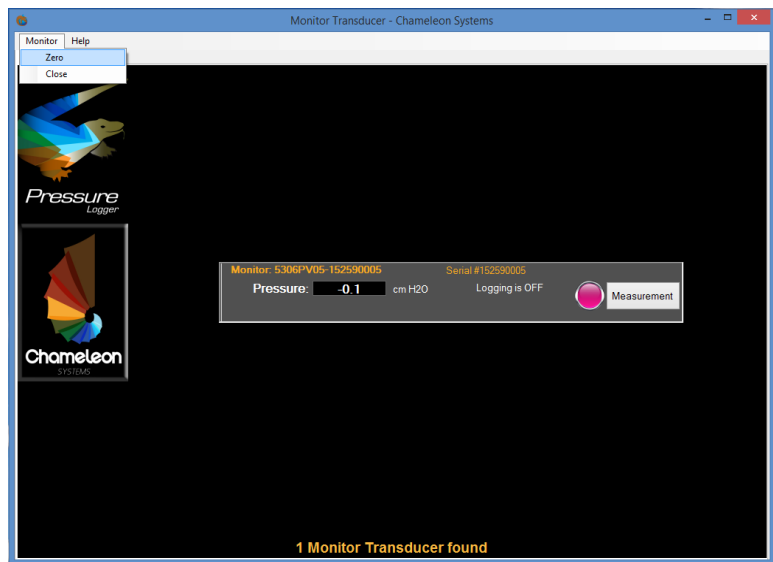

+ Once the sensor is zeroed, click on the “Measurement” button to go to the “Lab Saturated Hydraulic Conductivity System” window. Here you can perform your measurement campaign.

+ Select the “Constant Head” method.

+ In the “Log File Name” field, enter your log file name. This is the file that will contain your reading information. Try to come up with descriptive names for your reading files.

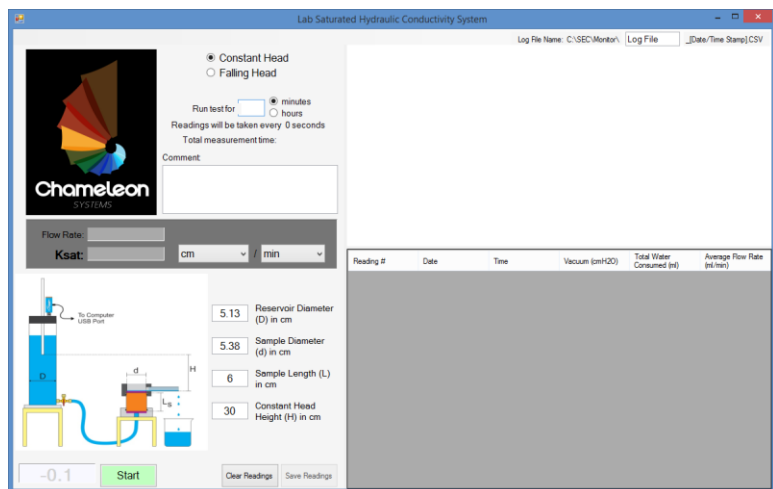

+ In the “Reservoir Diameter” field enter Reservoir inside diameter (D). The PR16 Reservoir has an inside diameter of 5.13 cm. Please also note that the outside diameter of Air Tube is assumed to be 0.635 cm (you are not able to change it).

+ In the “Sample Diameter” field enter Sample Ring inside diameter (d). The inside diameter of PR16 ring is 5.0 cm.

+ In the “Sample Length” field enter sample length (L_s). The length of the PR16’s sample ring is 5.0 cm.

+ Adjust the head height (H). The Constant Head schematic contains some useful dimensions.

+ Select a unit for measured Saturated Hydraulic Conductivity (Ksat) using dropdown menus in front of Ksat.

+ In the “Run test for” field, enter the duration of your measurement. As a rule of thumb, finer soils (more clay content) need longer measurement time. While coarser soils (more sand content) need shorter measurement time. The table below provides suggested head height and measurement time for each type of soil.

Soil Texture	Sand			Silt			Clay	
Relative Permeability	Semi-Pervious					Impervious		
Aquifer	Good		Poor				None	
Unconsolidated Sand and Gravel	Well Sorted Sand		Very Fine Sand, Silt, Loess, Loam					
Unconsolidated Clay and Organic	Peat			Layered Clay			Unweathered Clay	
Consolidated Rocks	Oil Reservoir Rocks			Fresh Sandstone		Fresh Limestone		
K (m/s):	1.E-03	1.E-04	1.E-05	1.E-06	1.E-07	1.E-08	1.E-09	1.E-10
Water Consumption Rate, Q (mL/min):	75.000	25.000	7.500	0.750	0.110	0.011	0.001	0.0004
Standard Reservoir								
Suggested Overhead Pressure, H (cm):	3.00	10.00	30.00	30.00	45.00	45.00	60.00	180.00
Suggested Measurement Time:	1 min	2 min	6 min	1 hr	3 hr	32 hr	10 day	1mnt
Low Flow Reservoir (not included)								
Suggested Overhead Pressure, H (cm):				30	45	45	60	180
Suggested Measurement Time:				5 min	20 min	3 hr	11 hr	40 hr

Suggested measurement parameters for standard Constant-head PR16 setup. Look up the suggested head height (H) and measurement time (T) based on measured Water Consumption Rate (Q). Note that the table is created based on Sample Diameter (D) of 5 cm and Sample Length (L) of 5 cm. Suggested Measurement Time is for making at least 5 consecutive readings.

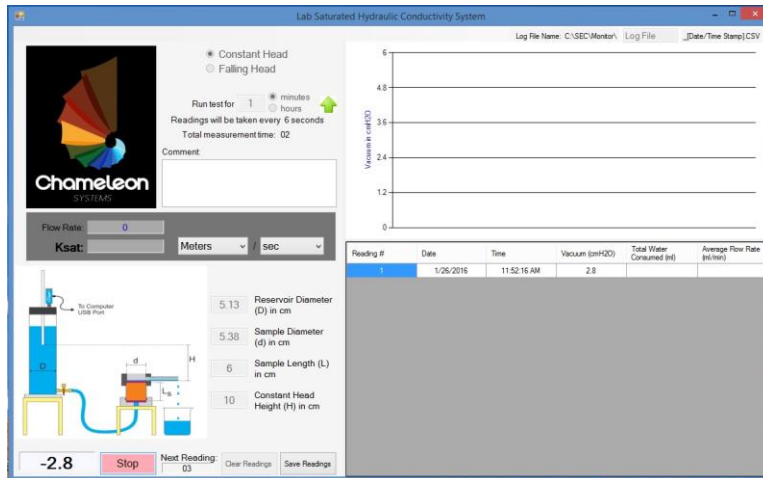

- + Make sure that the system is set up correctly. Valves A, B, C and D should be closed.
- + Open Valve D.
- + Open Valve A.
- + Wait until the Air Tube starts bubbling.
- + Wait for 5 more seconds for the system to stabilize.
- + Click the “Start” button to start a measurement.

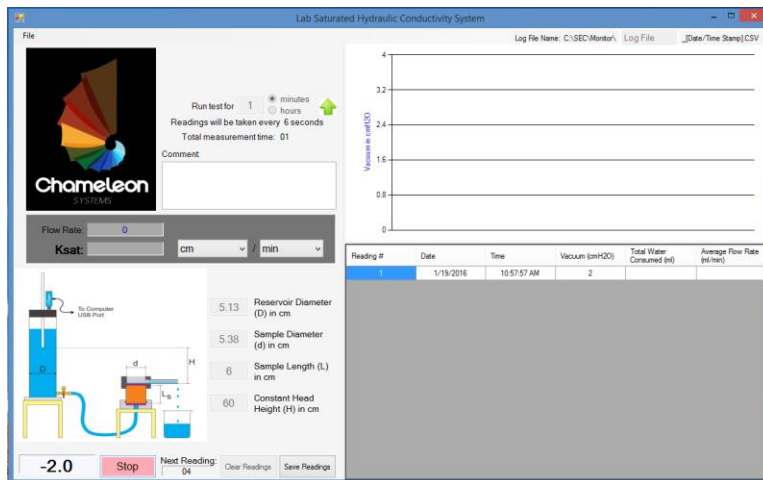

+ The first reading is made immediately. The software then divides the reading period into 10 equal increments and makes a reading at the end of each time increment. If the increments are too short, the readings graph is going to have a “step-like” trend (picture below). In that case you may want to increase the measurement time.

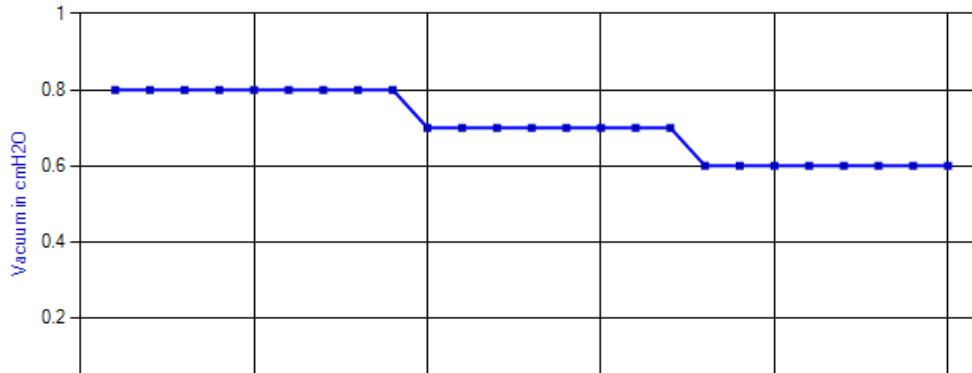

A step-like reading graph is an indication of a too short measurement time.

+ Once you get the first Average Flow Rate values, compare them with the measurement parameters table. If you need to readjust the head height or the measurement duration, do so and restart the measurement.

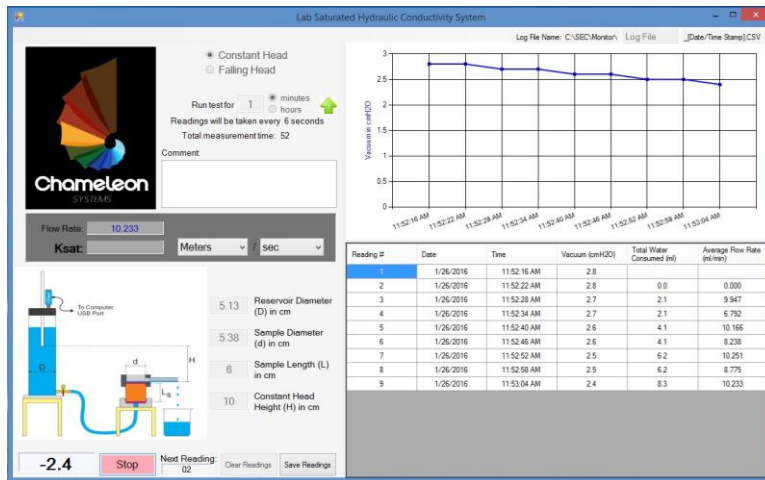

For example, looking at the reading graph in image above (one-minute measurement time), you are still able to see some “step-like” effect. In other words, some readings have similar reading values. A Step-like graph suggests that perhaps longer measurement duration gives you a more representative graph. Please note that a step-like graph does not mean that the measurement is wrong. We increased the measurement duration to 2 minutes for the same sample and restarted the measurement campaign. See how readings trend improved (image below).

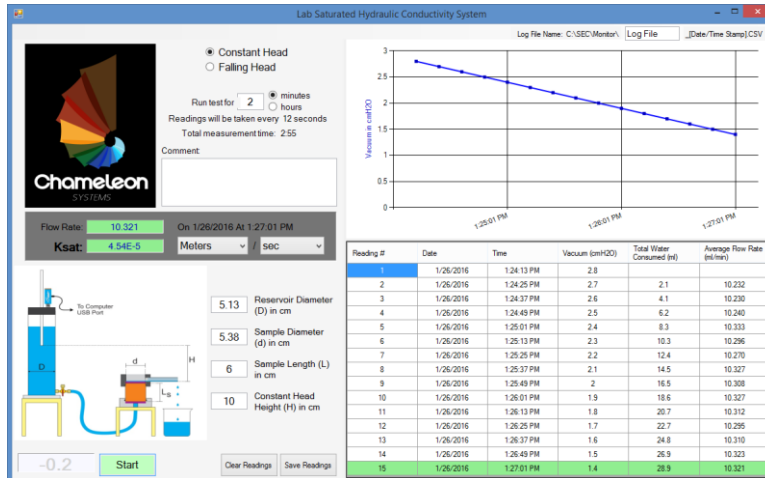

+ The Ksat value appears on the screen once the reading time is over (see the example screenshot above).

NOTE: The first reading and the last reading (green highlight in the Readings Table) are used for measuring the Average Flow Rate and then Ksat.

The software keeps reading until you press “Stop”. This is a handy feature when you decide to keep going with the measurement even after the designated measurement time is over. In case you need to increase the initial measurement time to a longer interval, use the green up arrow right beside measurement duration field.

+ Click “Stop” whenever you would like to stop the reading process. The software gives you an option to use the very last reading as the end point of your measurement. Click “Yes” if you would like to do so.

+ Click “Save” to save the readings and the results in a CSV file. The file address can be found at the top right corner of the measurement window. You can open the reading file in MS-Excel or other similar programs. Below is an example data file generated by the Chameleon software application.

K23						
	A	B	C	D	E	F
1	Chameleon Systems Constant Head Measurement					
2						
3	Monitor Name: 5306PV05-152590005					
4	Serial Number: 152590005					
5	Reservoir Diameter (D) in cm: 5.13					
6	Sample Diameter (d) in cm: 5.38					
7	Sample Length (L) in cm: 6					
8	Constant Head Height (H) in cm: 30					
9	Run test for: 1 minutes					
10	Comment:					
11						
12	Reading Number	Date	Time	Pressure (cmH2O)	Total Water Consumed (ml)	Average Flow Rate (ml/min)
13	1	1/19/2016	11:27:39 AM	1.1		
14	2	1/19/2016	11:27:46 AM	1	2.1	19.501
15	3	1/19/2016	11:27:51 AM	1	2.1	10.196
16	4	1/19/2016	11:27:58 AM	1	2.1	6.693
17	5	1/19/2016	11:28:04 AM	1	2.1	5.105
18	6	1/19/2016	11:28:10 AM	1	2.1	4.067
19	7	1/19/2016	11:28:15 AM	1	2.1	3.433
20	8	1/19/2016	11:28:22 AM	1	2.1	2.926
21	9	1/19/2016	11:28:28 AM	1	2.1	2.571
22	10	1/19/2016	11:28:33 AM	1	2.1	2.295
23	11	1/19/2016	11:28:40 AM	0.9	4.1	4.108
24	12	1/19/2016	11:28:45 AM	0.9	4.1	3.755
25	13	1/19/2016	11:28:52 AM	0.9	4.1	3.423
26	14	1/19/2016	11:28:58 AM	0.9	4.1	3.165
27	15	1/19/2016	11:29:04 AM	0.9	4.1	2.943
28	16	1/19/2016	11:29:09 AM	0.9	4.1	2.754
29	17	1/19/2016	11:29:15 AM	0.9	4.1	2.579
30	18	1/19/2016	11:29:21 AM	0.9	4.1	2.427
31	19	1/19/2016	11:29:28 AM	0.9	4.1	2.284
32	20	1/19/2016	11:29:33 AM	0.9	4.1	2.174
33						
34	Flow Rate: 2.174 ml/min		Ksat: 3.19E-6 Meters/sec			

Calculations

Since the soil sample is already saturated at the beginning of the measurement, the Average Flow Rate at the end of measurement campaign can be considered as the steady flow rate (Q). At each time increment, the Average Flow Rate is calculated using the first reading, the last reading and the elapsed time between the two readings:

$$Q = \frac{\Delta V}{\Delta t} = \frac{A_e \times \Delta h}{\Delta t} = \frac{A_e \times (h_n - h_0)}{(t_0 - t_n)}$$

Where Q is the steady-state flow rate (cm^3/min), V is the volume of water consumed (cm^3), A_e is the Reservoir effective cross-sectional area (cm^2), H_0 is the reservoir's water level (the vacuum level) at the beginning of the measurement (cmH_2O), H_f is the vacuum reading at the end of the measurement campaign (cmH_2O), t_0 is time at the beginning of the measurement (min) and t_n is time at the end of the measurement. Also A_e is:

$$A_e = A_c - A_a$$

Where A_c is the Reservoir cross-sectional area calculated from the Reservoir inside diameter and A_a is the Air Tube cross-sectional area calculated from the Air Tube's outside diameter. Please note that the Chameleon software assumes that the Air Tube's outside diameter is 0.635 cm.

Once Q is calculated, K_{sat} can be calculated as:

$$K_{sat} = \frac{Q \times L}{A_s \times H}$$

Where K_{sat} is the saturated hydraulic conductivity, Q is the steady-state flow rate, L is the sample length, A_s is the sample cross-sectional area and H is the hydraulic head difference applied to the sample.

Falling Head Method

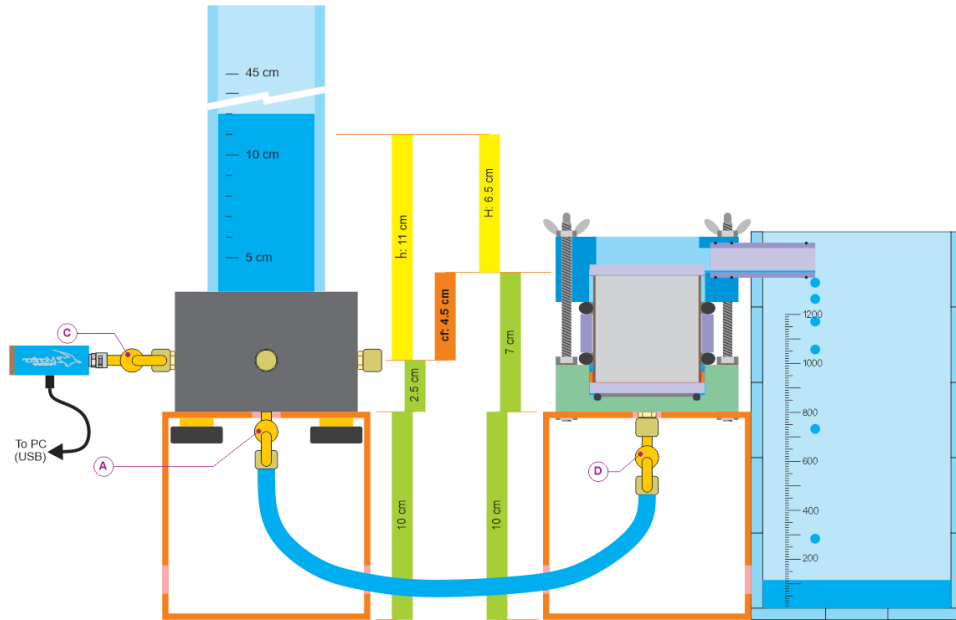

Falling Head Method system. Monitor Sensor is aligned slightly below the Top of the Flow Cell (recommended).

NOTE: In the Falling-head Setup the height of the Pressure Sensor should be lower than the top of the Flow Cell.

+ Determining the Correction Factor (*cf*).

Once the Monitor Sensor is connected to a Side Port of the Reservoir Base, the pressure that it measures (in cmH₂O) should agree with the readings on the Reservoir scale. For example, if the water level is at the 11 cm mark, the Monitor Sensor should also read a number close to or equal to 11 cmH₂O (you need to 'Zero' the Sensor if its measurement is significantly different from the correct measurement).

Note that the number that the Sensor is reading is not the actual pressure that is applied to the soil sample. The actual head height (*H* in the schematic above) is the height difference between the Sensor reading (*h* in the schematic above), and the top of the soil sample. The correction Factor (*cf*) converts the sensor reading (*h*) to the actual head height (*H*).

In a standard PR16 setup (schematic above) *cf* is **-4.5 cm** (see the schematic above).

Performing a Measurement (Falling Head Method)

+ Setup the system according to the Falling-head setup schematic.

NOTE: before filling up the Reservoir make sure that the Monitor Pressure Transducer is zeroed.

+Initial Position:

Valve C is open.

Valve A is closed.

Valve D is open.

NOTE: Make sure the soil sample is saturated and there are almost no air bubbles trapped in the water pathway from the Reservoir to the Flow Cell (a few very small air bubbles would not cause any problem).

+ Connect the Monitor Transducer to your computer using the USB cable provided with the system.

+ Open the Monitor Transducer program.

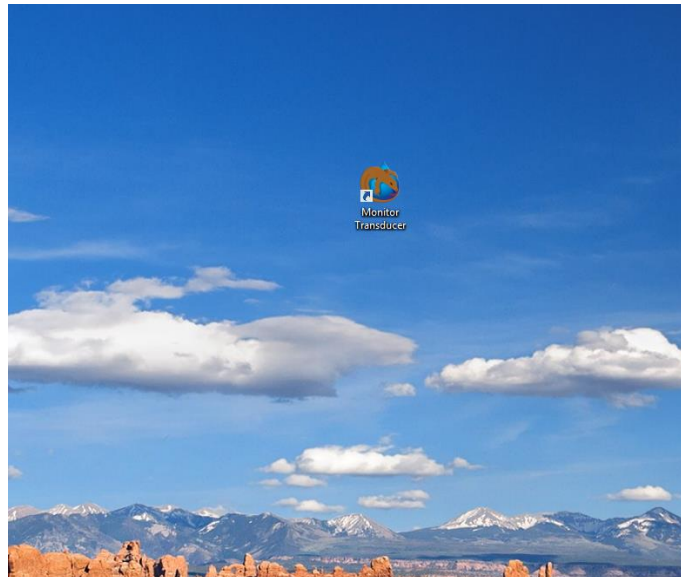

+ Select “Chameleon Systems” if it is not already selected.

+ Click on the “Measurement” on the corresponding sensor bar to go to the “Lab Saturated Hydraulic Conductivity System” window. Here you can perform your measurements.

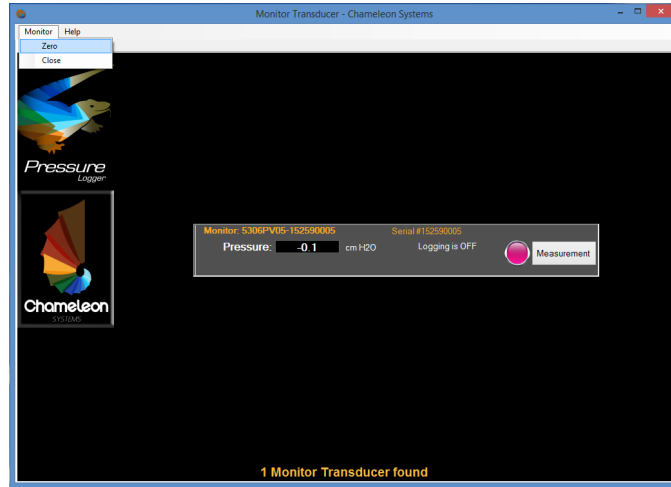

+ Select the “Falling Head” method.

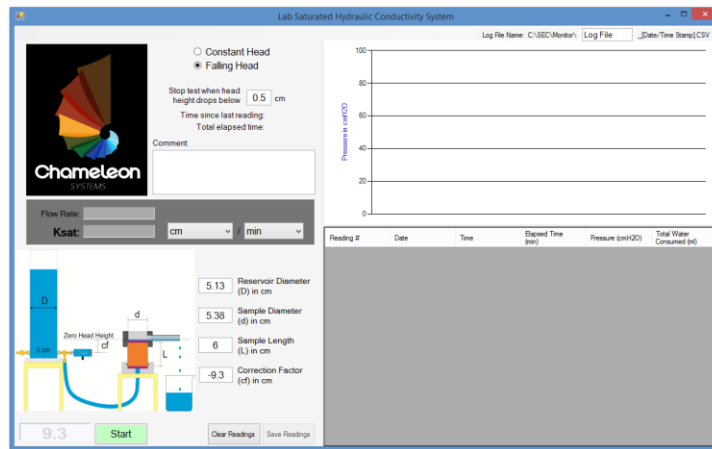

+ In the “Log File Name” field, enter a log file name. This is the file that will contain your reading information. Try to select a descriptive name for the file.

+ In the “Reservoir Diameter” field enter Reservoir inside diameter (D). The PR16 Reservoir ID is **5.13 cm**.

+ In the “Sample Diameter” field enter the Sample Ring inside diameter (d). The inside diameter of the PR16 standard ring is **5.0 cm**.

NOTE: the inside diameter of the PR16-8 is **8.0 cm**.

+ In the “Sample Length” field enter the sample length (L). The PR16 standard sample length is **5.0 cm**.

+ In the Correction Factor field, enter the Correction Factor (cf). Enter **-4.5 cm** for the standard PR16 setup.

NOTE: cf is a negative number. Do not forget to enter it with a negative sign.

+ You need to also set the end point water level. Once the water level subsides below this level, the reading campaign ends automatically. Note that you need to enter the Actual Head Height, H (not the sensor reading, h). In the standard setup (the schematic above), **0.5 cm** is a recommended end point.

+ Fill the Reservoir with water to the desired height. It is recommended to have enough water to create a “complete” curve. This depends on the soil type and the soil sample size. Fill the Reservoir more if the soil is expected to have high permeability. Perform a test run to get a feeling about the proper head height for starting the test.

NOTE: The Falling-head method is not recommended for slow soils. The reason is that creating a complete curve takes a very long time.

+ Once you are ready to start the measurement campaign, open Valve A.

+ Wait for 5 seconds to let the water flow stabilize, then click “Start”.

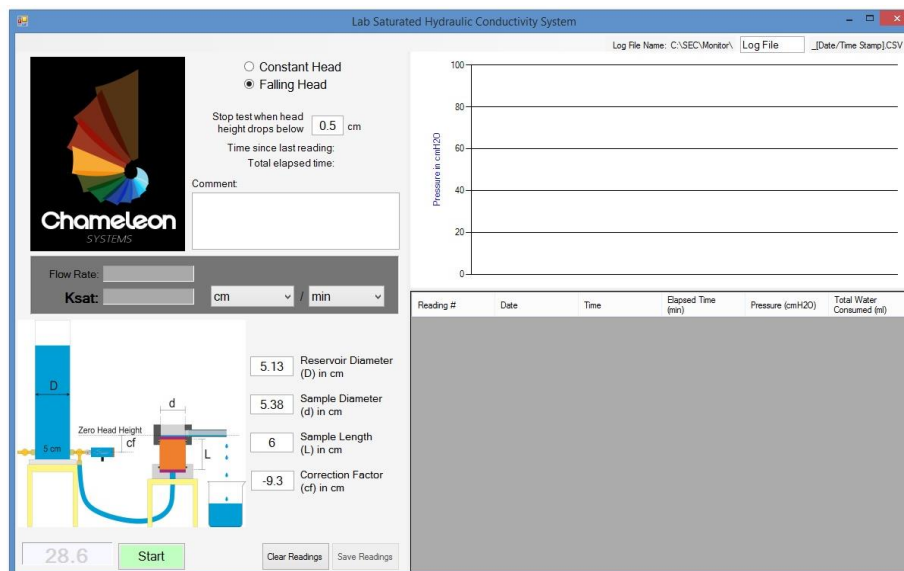

+ While the reading is in process, you have the option to change the endpoint water level to terminate the reading earlier. In the example here, we have changed the number from 0.5 cm (image above) to 2 cm (image below). Please note that the program records the readings once the pressure level drops below a detectable value. Therefore, reading intervals are not equal and become longer towards the end of the reading campaign.

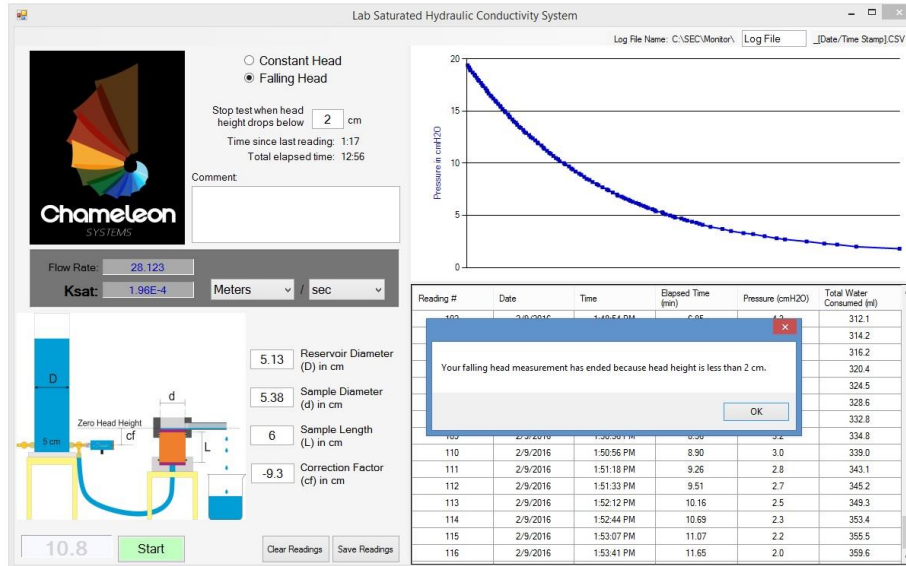

+ The K_{sat} value appears on the screen once the overhead pressure drops below the designated endpoint level (2 cm in this example). A pop-up window prompts the end of the reading campaign.

+ Click "Save" to save the readings and the results in a CSV file. The file address can always be found at the top right corner of the measurement window. You can open the reading file in MS-Excel or other similar programs. Below is an example data file generated by the Chameleon software application for a falling head reading campaign.

	A	B	C	D	E	F
1	Chameleon Systems Falling Head Measurement					
2						
3	Monitor Name: 5306PV05-152590005					
4	Serial Number: 152590005					
5	Reservoir Diameter (D) in cm: 5.13					
6	Sample Diameter (d) in cm: 5.38					
7	Sample Length (L) in cm: 6					
8	Correction Factor (cf) in cm: -9.3					
9	Stop test when head height falls below: 2					
10						
11						
12	Reading #	Date	Time	Elapsed Time (min)	Pressure (cmH2O)	Total Water Consumed (ml)
13	1	2/9/2016	3:25:36 PM	0.01	10.3	
14	2	2/9/2016	3:25:37 PM	0.03	10.2	2.1
15	3	2/9/2016	3:25:44 PM	0.14	10	6.2
16	4	2/9/2016	3:25:50 PM	0.24	9.9	8.3
17	5	2/9/2016	3:25:52 PM	0.27	9.7	12.4
18	6	2/9/2016	3:26:01 PM	0.42	9.5	16.5
19	7	2/9/2016	3:26:04 PM	0.49	9.4	18.6
20	8	2/9/2016	3:26:13 PM	0.62	9.2	22.7
21	9	2/9/2016	3:26:19 PM	0.73	9	26.9
22	10	2/9/2016	3:26:23 PM	0.8	8.9	28.9
23	11	2/9/2016	3:26:31 PM	0.93	8.7	33.1
24	12	2/9/2016	3:26:38 PM	1.05	8.5	37.2
25	13	2/9/2016	3:26:41 PM	1.09	8.4	39.3
26	14	2/9/2016	3:26:48 PM	1.22	8.2	43.4
27	15	2/9/2016	3:26:56 PM	1.34	8	47.5
28	16	2/9/2016	3:27:05 PM	1.49	7.9	49.6

Calculations

The overhead pressure (water height) variation over time has an exponential trend:

$$H_t = a \cdot \exp(-b \cdot t)$$

Where H_t is the overhead pressure at time t and a and b are coefficients of the exponential function.

Saturated Hydraulic Conductivity then can be calculated as:

$$K_{sat} = \frac{A_c}{A_s} \cdot L \cdot b$$

Where K_{sat} is saturated hydraulic conductivity, A_c is the Reservoir cross-sectional area, A_s is the sample cross-sectional area, L is the sample length and b is the coefficient of the fitted exponential function.

Coefficients a and b can be calculated using the following procedure:

$$a = \frac{\sum_{i=1}^n (x_i^2 y_i) \sum_{i=1}^n (y_i \ln y_i) - \sum_{i=1}^n (x_i y_i) \sum_{i=1}^n (x_i y_i \ln y_i)}{\sum_{i=1}^n y_i \sum_{i=1}^n (x_i^2 y_i) - (\sum_{i=1}^n x_i y_i)^2}$$
$$b = \frac{\sum_{i=1}^n y_i \sum_{i=1}^n (x_i y_i \ln y_i) - \sum_{i=1}^n (x_i y_i) \sum_{i=1}^n (y_i \ln y_i)}{\sum_{i=1}^n y_i \sum_{i=1}^n (x_i^2 y_i) - (\sum_{i=1}^n x_i y_i)^2}$$

To fit a functional form

$$y = A e^{Bx},$$

where $B \equiv b$ and $A \equiv \exp(a)$

Where y is overhead pressure, x is time and i is the reading number.

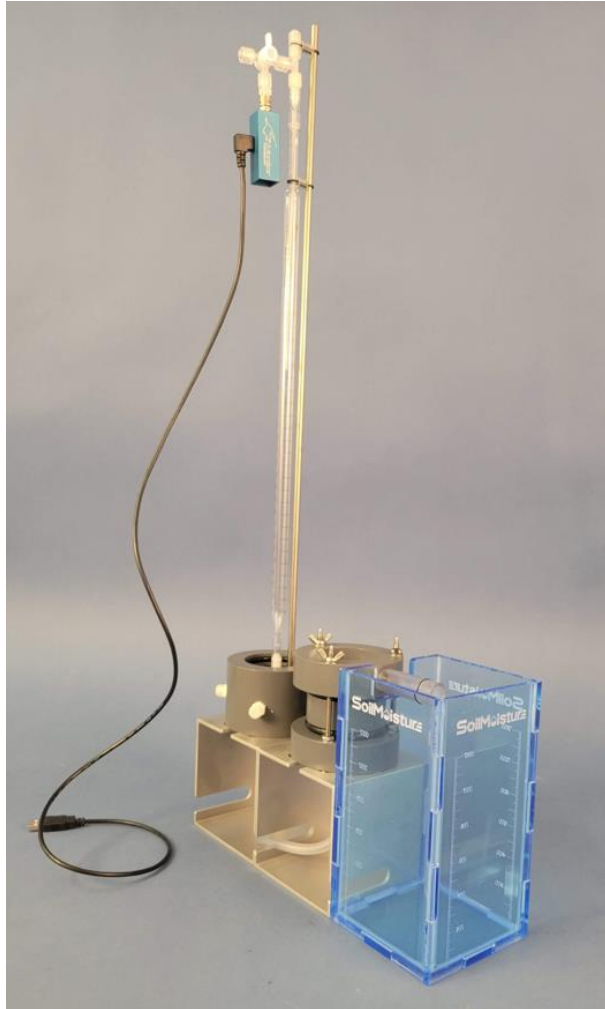

A Constant Head Setup for the **Slow Soil Attachment** (Sold separately).

A pipette reservoir is used to shorten the measurement time.



A Falling Head Setup for the **Fast Soil Attachment** (Sold separately).

The Reservoir Body Pipe is placed directly over the soil sample to maximize the water supply rate.